

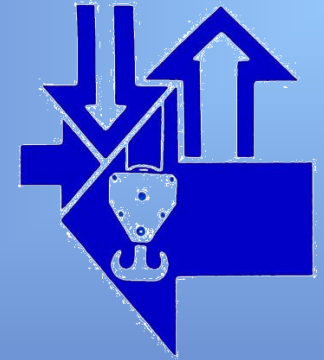

*OVERHEAD CRANE-HOIST-JIB CRANE
ATEX PLANT – OFFSHORE PLANT – MILITARY CRANE SUPPLY
UNDERRUNNING CRANE - GANTRY CRANE*

**Via Giovanni Falcone n°8
41057 Spilamberto (MO)
Tel 059/785979 – Fax 059/785937
url: www.emmegiesse.com
www.offshore.emmegiesse.com
Mail: info@emmegiesse.com**

FACTORY



EMMEGIESSE S.r.l., was established, and now it boasts in its staff of figures, who exist in the sector of heavy loads lifting as far back as sixties, and who helped to make EMMEGIESSE the leader in the sector by offering always high quality products.

EMMEGIESSE S.r.l. before with ICAM STAHL, then with VERLINDE has undertaken a collaboration to improve among other things, the part of research and development in order to be able to have always the best product.

EMMEGIESSE S.r.l. supplied complete system for medium and heavy loads lifting

OVERHEAD CRANE

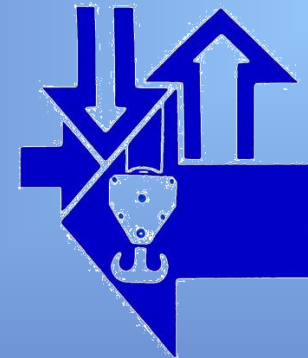

OVERHEAD CRANES

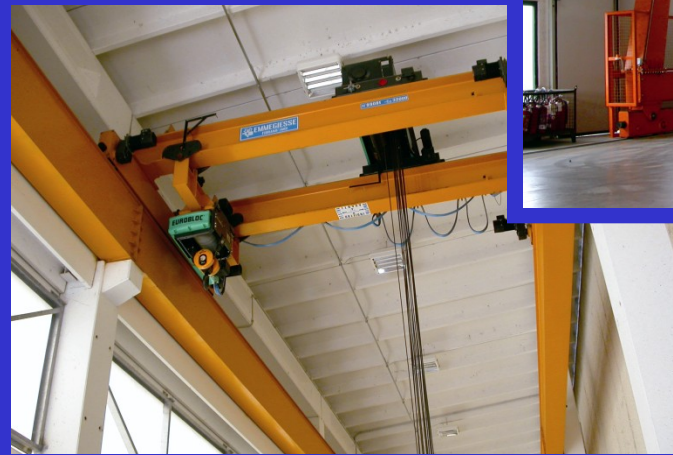

OVERHEAD CRANE HIGH CAPACITY



OVERHEAD CRANE HIGH CAPACITY



OVERHEAD CRANE HIGH CAPACITY



LIGHT EQUIPMENTS

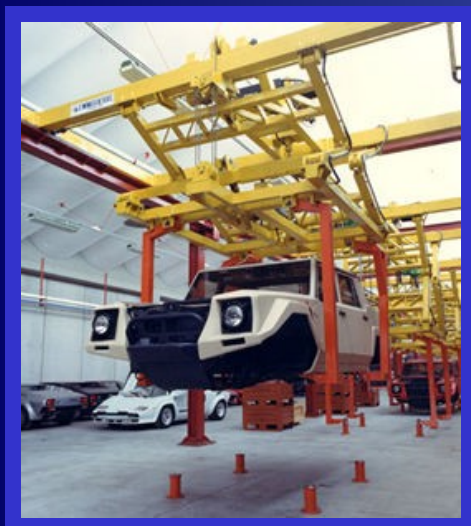
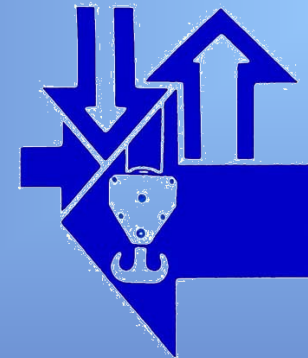

JIB CRANE and WALL JIB CRANE

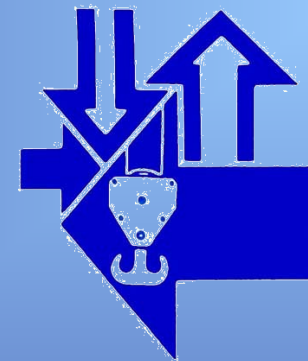

SPECIAL APPLICATION

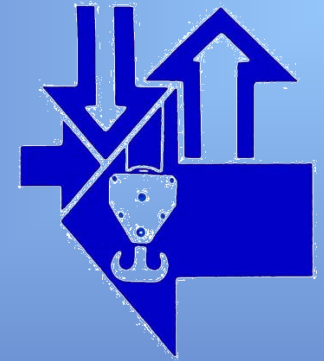

ATEX CRANE

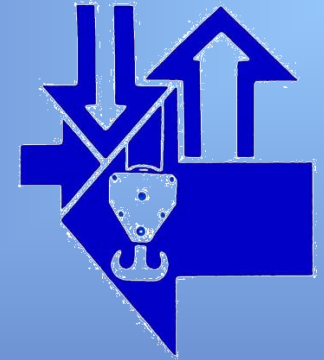

- Offshore Platforms (Oil & Gas)
- Oil Refineries
- Chemical Plants
- Waste Water Treatment
- Paint Shops
- Gas Power Plants
- Printing

ATEX CRANE

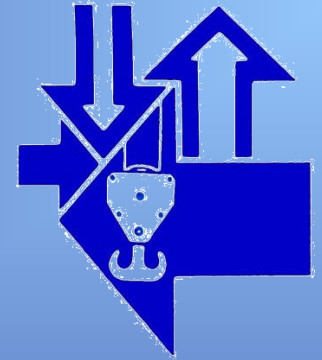

ATEX CRANE

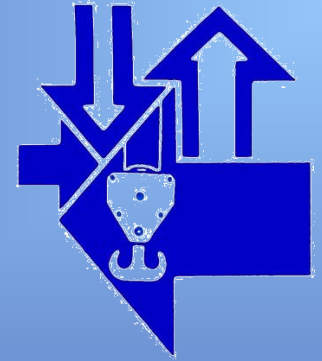

Off Shore *CRANES*



ABS

Setting Standards of Excellence in Marine & Offshore Classification



**BUREAU
VERITAS**

BUREAU VERITAS ITALIA

Off Shore Cranes

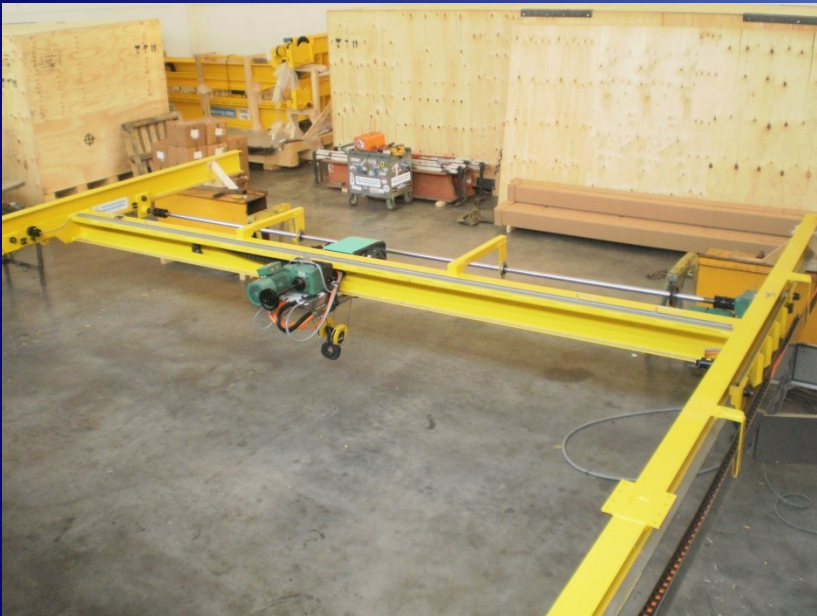

MILITARY SUPPLY



Automatic PLant



MAINTENANCE

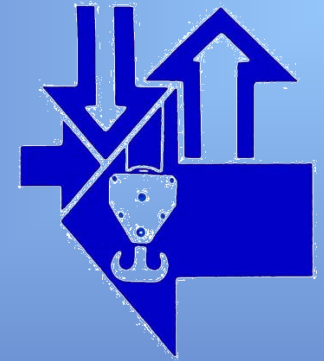

MAINTENACE INTERFACE INTERNET WEB PAGE

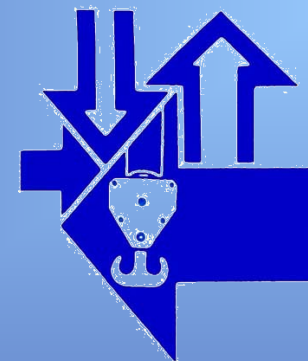

PLANMANAGER
POWERED BY LYNX2000

| LYNX2000 | ACCESSO PROTETTO

UTENTE

PASSWORD

Accesso protetto al software

- Inserire il proprio nome utente
- Inserire la propria password
- Premere il pulsante accedi

PLANMANAGER
POWERED BY LYNX2000

MENU AMMINISTRAZIONE

Gestione clienti
Gestione tecnici
Inserimento interventi
Modifica interventi
Agenda giornaliera
Agenda settimanale
Agenda mensile
Sospesi
Ricerca avanzata
Storico interventi
Uscita dal programma
Lu Ma Me Gi Ve Sa Do
1 2 3
4 5 6 7 8 9 10
11 12 13 14 15 16 17
18 19 20 21 22 23 24
25 26 27 28 29 30
« Settembre 2006 »

GESTIONE CLIENTI

*Azienda	
*Referente	geom. ferri
*E-mail	uff.tecnico@emmegiesse.com
*Indirizzo	Via leon...
*Comune	mon... emilia
*Cap	42027
P. IVA	00275000354
C. Fiscale	
*Tel	0522-...
*Fax	0522-...
*Km distanza	125
Username	
Password	
Attivazione	15 05 2006
Scadenza	15 05 2007
↳ Contratto di Manutenzione	
Trimestrale	0.00
Semestrale	0.00
Annuale	0.00

MENU SELEZIONE

Trovati 62 risultati	
Ape SPA	<input type="checkbox"/>
B.G.S. SRL	<input type="checkbox"/>
Bozza, Autostar	<input type="checkbox"/>
C.N.P. di Pizzi C	<input type="checkbox"/>
CA' TONI s.r.l.	<input type="checkbox"/>
Co.p.raulic s.	<input type="checkbox"/>
COAS s.n.c.	<input type="checkbox"/>
Credito fido s.r.l.	<input type="checkbox"/>
EMMEGIESSE S.r.l.	<input type="checkbox"/>
Etmfilter s.p.	<input type="checkbox"/>
Laromex 2001 s	<input type="checkbox"/>
F.lli Ferri	<input type="checkbox"/>
Pag: 1 2 >>	
ELIMINA	

Engineering

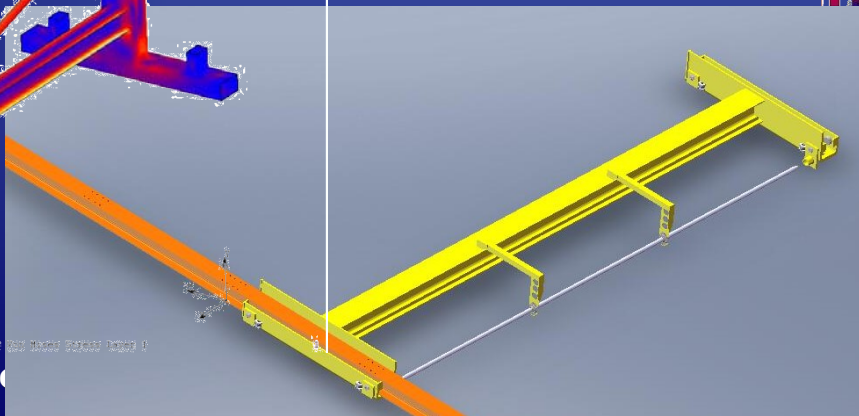
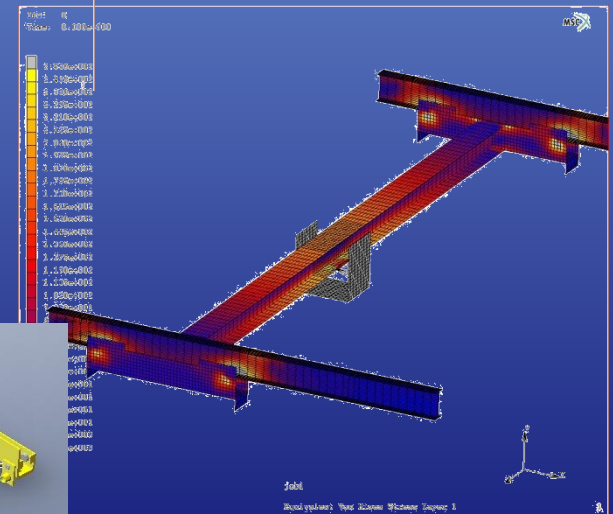
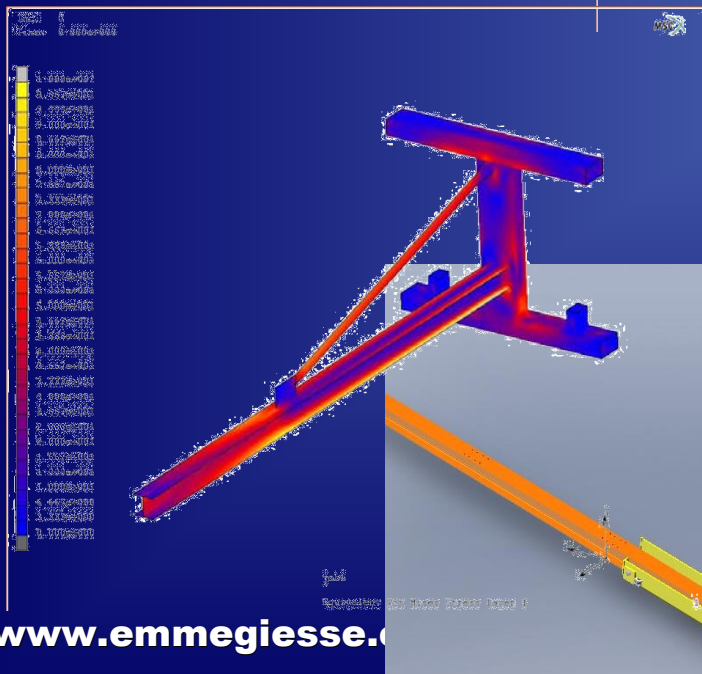
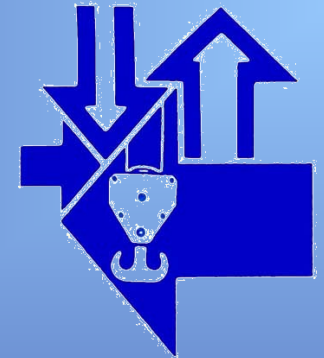
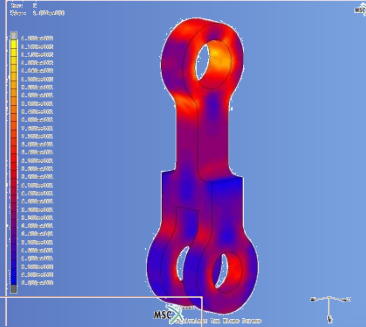
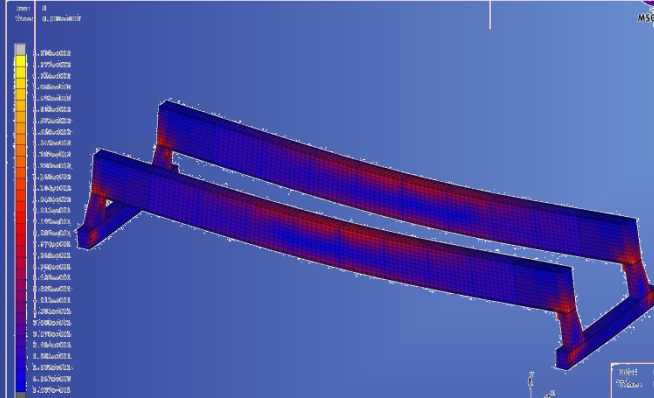
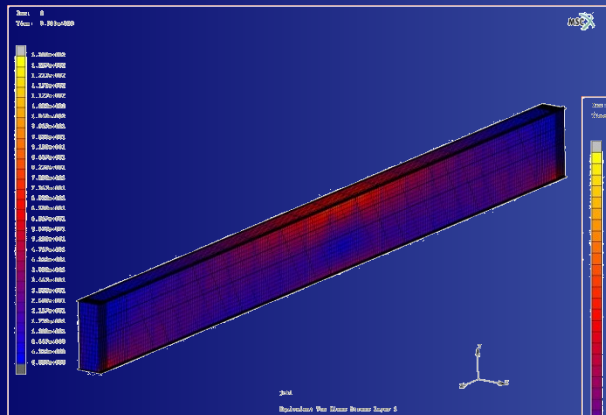

TESTING

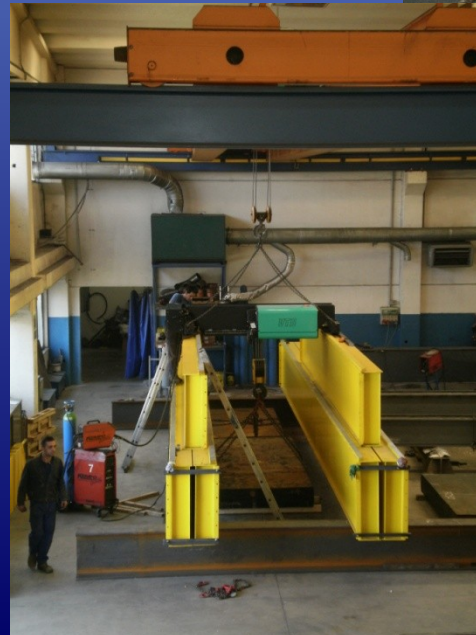

Reference List



Contact

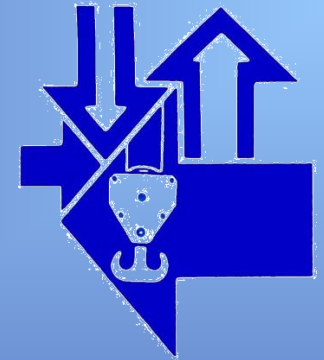

Management : gilli@emmegiesse.com

Amministation : amministrazione@emmegiesse.com

Tech. Dept : uff.tecnico@emmegiesse.com

Comm. Dept : uff.commerciale@emmegiesse.com

General : info@emmegiesse.com