

EUROLIFT *BH*

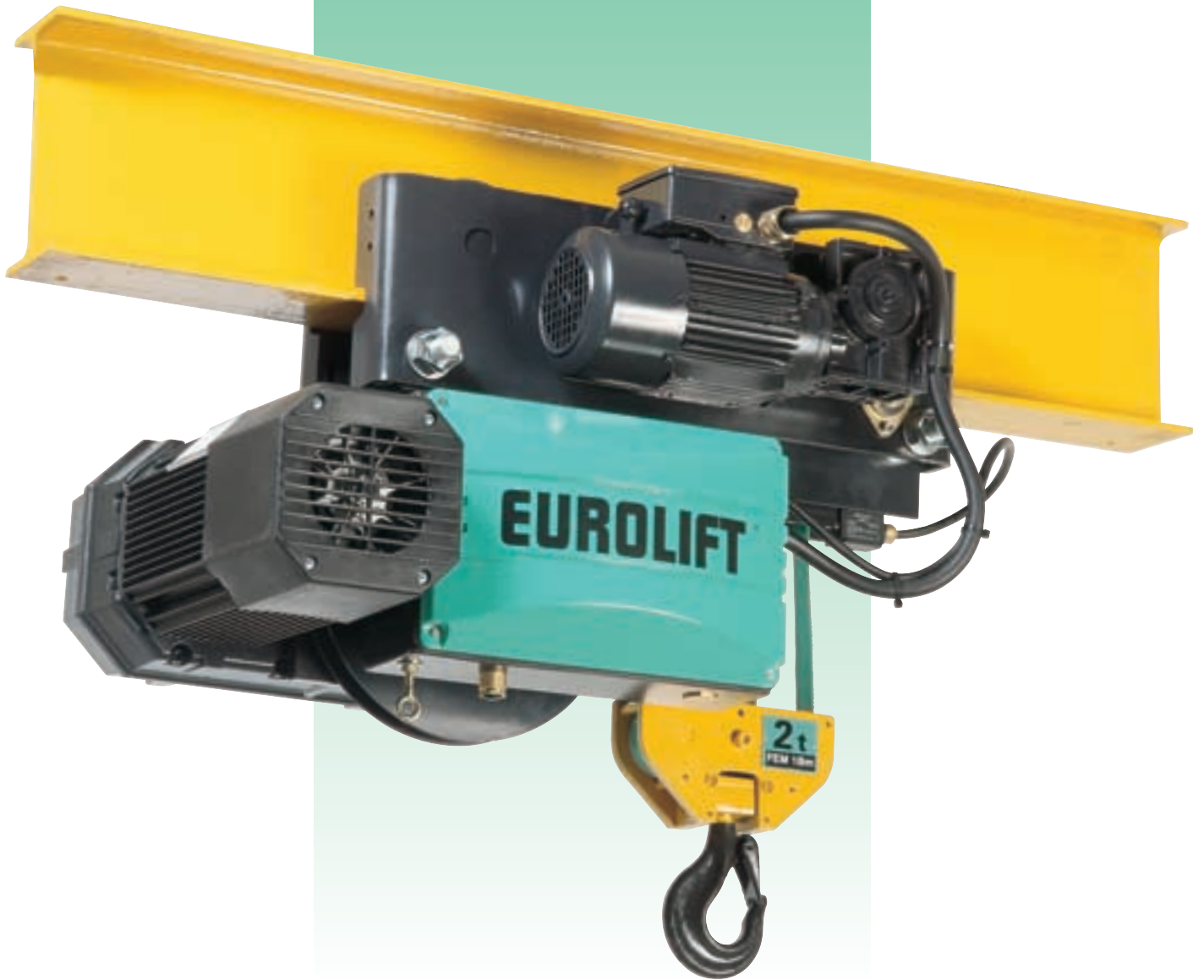

**Electric belt hoist
for load from 500 up to 5000 kg**



2, boulevard de l'Industrie - B.P. 59 - 28501 Vernouillet cedex - France

Telephone: (33) 02 37 38 95 95 - Fax: (33) 02 37 38 95 99

Internet : www.verlinde.com

Réf : JV 07 02 35 U

The leading French manufacturer of lifting equipment

VERLINDE is the leading French manufacturer of hoisting equipment, capable of mass producing belt, cable and chain hoists, winches, jib cranes and bridge crane components, at its VERNOUILLET plant. From CAD / CAM design to execution, manufactured with amongst the most up-to-date machining facilities in any plant in Europe and backed by the skill and know-how of our experienced personnel, each hoist bearing the **VERLINDE** logo is a warrant for the user of both reliability and quality.



New products, new concepts

Attuned to the needs of its customers, **VERLINDE** has designed this belt hoist for customised applications in a wide variety of sectors such as the food industry, chemicals, the precision industries and, indeed, any environment where hygiene and safety are of utmost importance to quality production.

VERLINDE has always been amongst the first to introduce new ideas in operation of hook hoisting units.

The **EUROLIFT BH** electric belts hoist has been designed with this resolutely innovative attitude, as witnessed by the fact that its design alone has given rise to 3 patents.

The **EUROLIFT BH** is today the only belt and hook hoisting unit offering you the following features in its standard version:

- Hoisting belt: high strength belt with high safety factors, easy and quick to replace, thanks to its design.
- Two mechanically variable hoisting speeds.
- Belt guide: enhanced safety features against side pulling and twisting effects during lifting movement.
- Hoisting and control features complying with IEC 34.1/IEC 34.2, IP 55 protection and class insulation standard.
- Totally enclosed, high precision, silent and sealed reduction gear.
- Adjustable upper and lower limit switches.
- Travelling limit switches.
- Load limiter, safety feature protecting against excessive overloading of the pulley and runway path. (mandatory, to comply with the "MACHINES" Directive).
- Very low "C" dimensions and hook "approaches".
- True vertical lift (vertical movement of hook block when hoisting)
- and yet more features that you will find in the following pages ...

EUROLIFT BH standard hoist

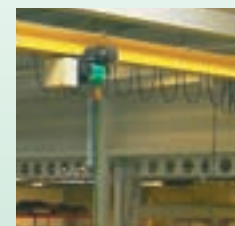
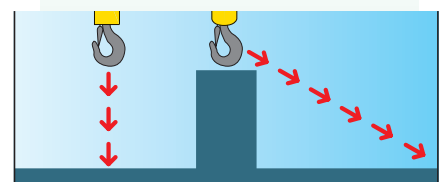

EUROLIFT *BH*

Electric belt hoist for load from 500 up to 5,000 kg

Customised installations



Fixed version

These hoists do not have a trolley and are designed for applications where no horizontal travel is needed. Maximum capacity: 5.000 kg.

Monorail short headroom powered travel trolley (HPR)



These hoists feature a trolley (for moving the load in the horizontal direction) with a design enabling the user to make optimum use of the headroom and working area available for your job. Maximum capacity: 2.000 kg.



Monorail short headroom hand-push travel trolley (HPR)

These hoists feature a trolley (for horizontal movement of the load) with a design enabling loads of up to 5000 kg to be moved with optimised hoisting height.



Monorail trolley into EUROSYSTEM profile

These hoists feature a travelling trolley (for horizontal movement of the load). They are capable of lifting a load of up to 2000 kg and moving it horizontally in a straight or curved EUROSYSTEM profile.

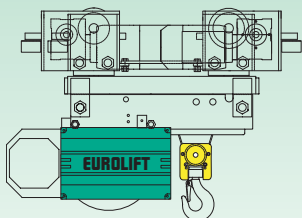

Monorail powered boggy trolley for curved beams.

Ces palans disposent de chariot (mouvement horizontal de la charge). Lever une charge jusqu'à 2000 kg et la déplacer horizontalement sur une voie courbe.

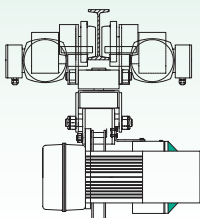

EUROLIFT BH "Stainless steel" version

Lifting of loads of up to 2000 kg with horizontal travel in an environment with a high level of relative humidity.

EUROLIFT

Electric belt hoist for load

Gear box



3 steps helical gear, life-lubricated (semi-fluid grease), comprising O-ring seals and lip seal at shaft end (BH2).

Lifting motor



2-speed motor, electromagnetic brake featuring automatic wear compensation. IP 55 protection. Class F insulation.

Electric cubicle

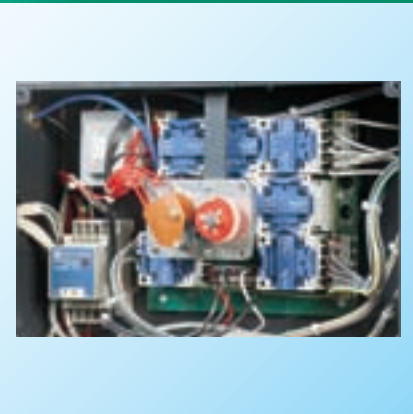

- 48V low voltage control.
- Printed circuit for standard voltage.
- NFE 52070 standard
- Upper and lower limit switches
- Hoisting motor protected by thermal sensors
- IP 65-protected low voltage control push button box.



Safety

Travelling.

2 travelling speeds (20/5 m/min. 10 2,5 m/min and BH2)

for more accurate positioning of your loads

Belt. Excellent ability to withstand attack by acids, immune to solvents, rot-proof and fire retardant

Electrical cubicle. 48 V control. The cover is equipped with two anti-drop type steel safety cables (BH2) or hinges (BH5).

Belt guide. high safety feature against side pulling and twisting effects during hoisting movement.

Savings

Lifting motor. High operating factor ensuring longer service life.

Hook block. Small "C" dimensions and hook "approaches", enabling you to design your building to optimum size and make maximum use of the available working space.

Travel. Travelling motor with IP 55 protection and type F insulation, ensuring maximum service life.

Ergonomics

Push button box. With in-depth colored polypropylene with double insulation and ergonomic design (IP 65 protection).

New technology



LIFT BH

loads from 500 up to 5,000 kg



High
safety

High technology

Hook block. The hook block moves vertically during hoisting (hoisting is centred).

Belt guide. No fouling of the guide system, whether used in any type of environment.

Drum. The very high ratio of the belt diameter/drum extends the service life of the belt.

Electrical cubicle. Generously dimensioned, comprising all electrical components as standard.

Easy maintenance

Lifting motor. Improved cooling of the motor, thanks to its mounting position outside the hoisting unit.

Motor, trolley gear box. Lifetime-lubricated travel gear box.

Hoisting brake. The brake features automatic compensation of wear and is tested for the service life of the hoist working under normal operating conditions.

Belt guide. "Springless" construction principle, making for easier replacement during maintenance operations.

Electrical cubicle. Mounted on the front face (BH2) or rear face (BH5) of the hoist, featuring ready access and openable by a snap-action system.

Stainless steel version of electric belt hoist for loads from 500 up to 5,000 kg

Power travelling trolley. Wheels, axes and diverter sheaves undergo anti-corrosion treatment to improve protection against external sources of aggression. The side plates of the trolley and spreader and the plates of the structure are hot dipped galvanised. The side plates of the drum and the drum support are hot dipped galvanised.

Hook block. Hook, lower cross head and bearing are in stainless steel, for applications in environments with a high level of relative humidity.

Gear box. The gear box mounting is hot dipped galvanised for anti-corrosion protection.



Lifting belt



High strength polyester belt. Flame-retardant with good dimensional stability and excellent ability to maintain its strength after immersion in boiling water.

Excellent ability to withstand attack by acids.

immune to attack by solvents.

Rot-proof.

BH5: Dynema belt (this belt has the same characteristics as those of the BH2, with a greater safety factor).

Hook block



Possibility of stainless steel hook block and hook.

Overload limiter



The hoist has a load limiter as standard equipment, preventing hoisting in the event of overloads (in compliance with the European "MACHINES" Directive).

EUROLIFT BH

Electric belt hoist for load from 500 up to 5,000 kg

Options

The EUROLIFT BH can be equipped with a great many options and can be specifically adapted for special purpose uses:

- Non standard beam section width
- Higher travelling speeds
- Time counter
- EUROMOTE type infrared or radio remote-control
- Travelling movement limit switch
- Trolley mounted on bogies
- Special power supply voltage
- Tropicalised travelling movement and lifting motors
- Load limiter with 2 or 3 steps
- Stainless steel hook and hook block (**)
- Total anti-corrosion protection. (*)
- Covering roof for protection against rain.
- Horn controlled from push button box.
- Explosion-proof hoist.

(*) except BH5.

(**) up to 2.5 T only. 3.2 T and 5 T stainless steel hook block, painted hook.



Standards and hoisting regulations



Compliance with EC Directive. Since 1st January 1995, the "EC" standard on machines 98/37/EEC, requires manufacturers of machines to harmonise their production to comply with certain provisions, standards, national rules of practice and technical specifications. Each VERLINDE unit bears the "EC" label and is delivered with an "EC" certificate of conformity (appendix IIA) or has a built-in certificate (appendix IIB).

FEM : The European Handling Equipment Federation.

SWP : Safe Working Period. The "Safe Working Period" of the hoisting unit is determined in terms of average type of use of the hoisting mechanism, load range and utilisation group. After this period has elapsed, the unit must undergo a the general overhaul as prescribed by the maker.

Class of operation. In accordance with FEM classification, two fundamental criteria must be allowed for: the level of load and stress of the hoist, and the operating categories (related to the average daily use and hoisting movement of the unit).

ISO standard. The utilisation groups can also be defined in terms of ISO groups (1Am = M4, 2m = M5, 3m = M6,...).

Load status. Light duty service: the unit is subjected to maximum loads only under exceptional circumstances, with very light loads the majority of the time. **Average duty service:** the unit handles maximum loads fairly often, and frequently light loads. **Heavy duty service:** the unit is frequently subjected to maximum loads and normally to average loads. **Very heavy duty service:** the unit is regularly subjected to loads approaching the maximum.

| Average daily operating time (hours) | | | 0,5 | | 1 | | 2 | | 4 | | 8 | | 16 | |
|--------------------------------------|---|---------------|-------|----|------|----|-----|----|-----|----|-----|----|----|----|
| Class of duty | | | V0,25 | T2 | V0,5 | T3 | V1 | T4 | V2 | T5 | V3 | T6 | V4 | T7 |
| Type of service | 1 | L1 Light | | | | | 1Bm | M3 | 1Am | M4 | 2 m | M5 | V4 | M6 |
| | 2 | L2 Medium | | | 1B m | M3 | 1Am | M4 | 2 m | M5 | 3 m | M6 | | |
| | 3 | L3 Heavy | 1Bm | M3 | 1A m | M4 | 2 m | M5 | 3 m | M6 | | | | |
| | 4 | L4 Very heavy | 1Am | M4 | 2 m | M5 | 3 m | M6 | | | | | | |

| Group | | | | | 1Bm | M3 | 1A m | M4 | 2 m | M5 | 3 m | M6 |
|--------------------------|--|--|--|--|------|----|------|----|------|----|------|----|
| Duty factor* | | | | | 25 % | | 30 % | | 40 % | | 50 % | |
| Number of start per hour | | | | | 150 | | 180 | | 240 | | 300 | |

■ F.E.M. 9511 standards classification ■ ISO standards.

* Operating factor in percentage terms = $\frac{\text{Hoisting time} + \text{Lowering time}}{\text{Hoisting time} + \text{Dwell time} + \text{Lowering time} + \text{Dwell}} \times 100$

EUROLIFT BH

Electric belt hoist for load from 500 up to 5,000 kg

Technical characteristics

Dimensions of the EUROLIFT BH 2*

| Hoist type | Number of falls | C in mm | |
|------------|-----------------|----------|---------------|
| | | Standard | Stainless st. |
| BH2 | 2 | 390 | 390 |
| | 3 | 435 | 465 |
| | 4 | 400 | 430 |

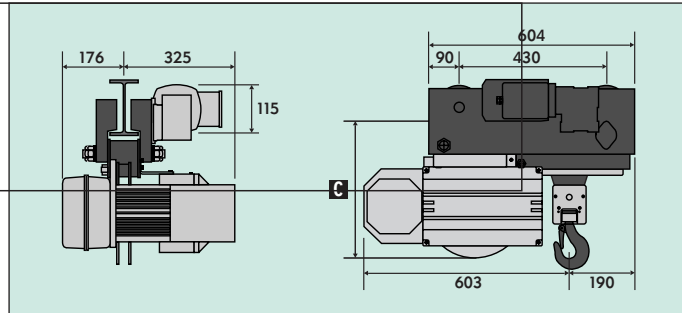

Weight of hoist: 145 (kg).

* For the overall dimensions of the EUROLIFT BH 5, consult us.

EUROLIFT range

| EUROLIFT type | S.W.L (kg) | F.E.M. Group | Number of falls | Height of lift (m) | Lifting speed (m/min) | Travelling trolley | | | |
|---------------|------------|--------------|-----------------|--------------------|-----------------------|--------------------|---------------------|---------------------------|--|
| | | | | | | Push trolley | Chain drive trolley | Motorized 1 speed trolley | |
| BH2 02 R3 | 500 | 1Bm | 2 | 9,00 | 20 / 3,3 | X | X | X | Lifting motor power (kW) 1.9 / 0.3 |
| BH2 03 R5 | 500 | 2m | 3 | 6,00 | 13 / 2 | X | X | X | |
| BH2 02 L5 | 630 | 2m | 2 | 9,00 | 10 / 1,6 | X | X | X | |
| BH2 03 R4 | 630 | 1Am | 3 | 6,00 | 13 / 2 | X | X | X | |
| BH2 02 L4 | 800 | 1Am | 2 | 9,00 | 10 / 1,6 | X | X | X | |
| BH2 03 R3 | 800 | 1Bm | 3 | 6,00 | 13 / 2 | X | X | X | |
| BH2 02 L3 | 1000 | 1Bm | 2 | 9,00 | 10 / 1,6 | X | X | X | Travelling motor power (kW) 0.25 / 0.06 |
| BH2 03 L5 | 1000 | 2m | 3 | 6,00 | 6,5 / 1 | X | X | X | |
| BH2 03 L4 | 1250 | 1Am | 3 | 6,00 | 6,5 / 1 | X | X | X | |
| BH2 04 L5 | 1250 | 2m | 4 | 4,50 | 5 / 0,8 | X | X | X | |
| BH2 03 L3 | 1600 | 1Bm | 3 | 6,00 | 6,5 / 1 | X | X | X | |
| BH2 04 L4 | 1600 | 1Am | 4 | 4,50 | 5 / 0,8 | X | X | X | |
| BH2 04 L3 | 2000 | 1Bm | 4 | 4,50 | 5 / 0,8 | X | X | X | Lifting motor power (kW) 1,9/0,3 3,5/0,5 |
| BH5 04/RN1 | 2500 | 2m | 1x4 | 5,90 | 3,8/0,6 | - | - | X | |
| BH5 04/RN2 | 3200 | 1Bm | 2x2 | 8,20 | 5,9/0,9 | - | - | X | |
| BH5 08/RN2 | 5000 | 1Am | 2x4 | 5,90 | 3,8/0,6 | - | - | X | Travelling motor power (kW) 0,55 |

X: available in this version: -: not available in this version

Range of loads

| | 500 kg | 630 kg | 800 kg | 1000 kg | 1250 kg | 1600 kg | 2000 kg | 2500 kg | 3200 kg | 5000 kg | |
|-----|--------|--------|--------|---------|---------|---------|---------|---------|---------|---------|--|
| BH2 | █ | | | | | | | | | | |
| BH5 | | | | | | | █ | | | | |

Explanation of EUROLIFT BH codification *

| BH2 | 04 | L | 3 |
|-----------------|-----------------|---------------------|--|
| Hoist body type | Number of falls | Hoist gear box type | FEM Group 3 = 1Bm, 4 = 1Am, 5 = 2m |

*except BH5

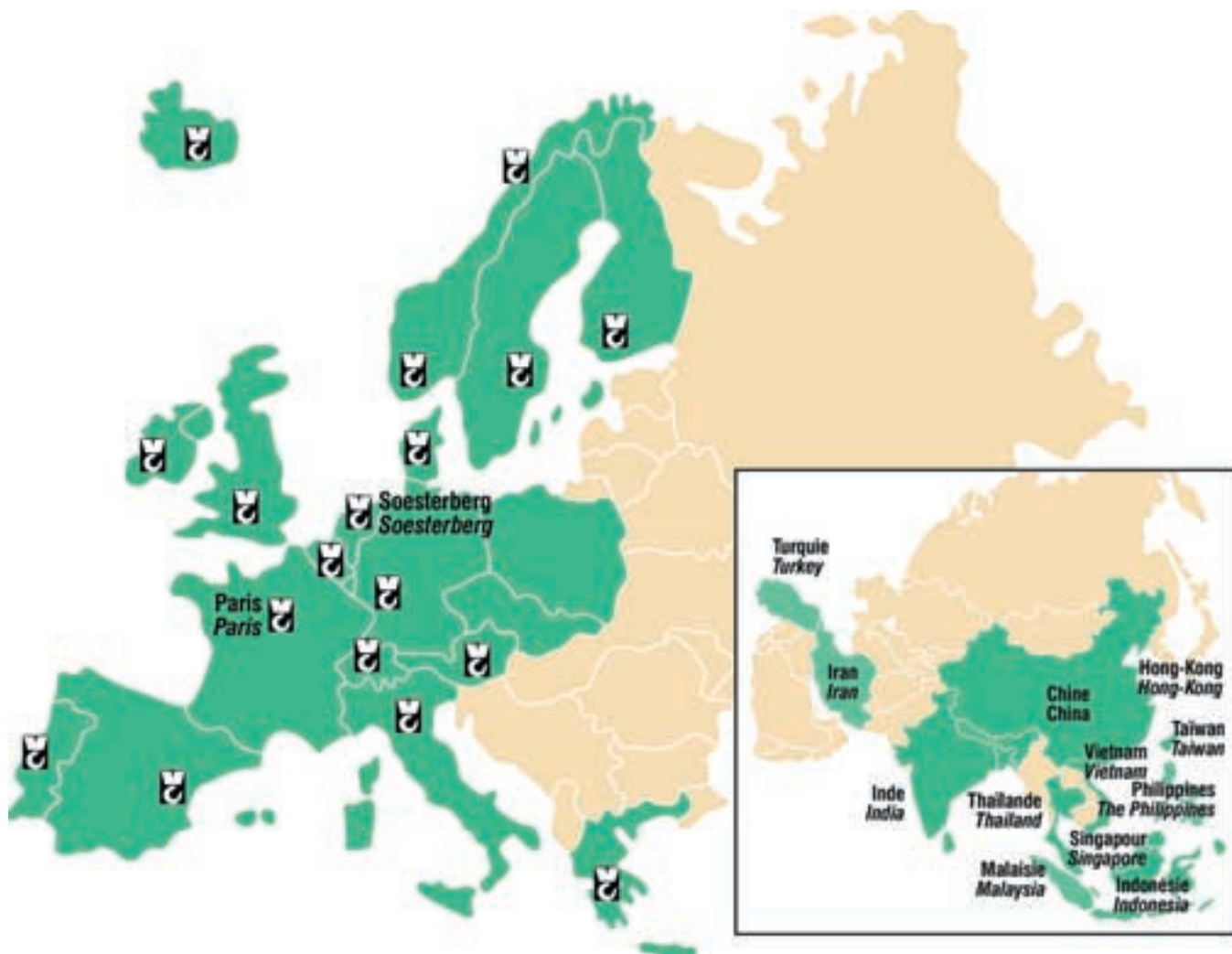

With VERLINDE, you have:

- The leading French manufacturer and exporter of hoisting and handling equipment.
- The power of a Group employing 5000 persons.
- A continuous product line comprising 30 different models
- Equipment built to the standards of the ISO 9001 quality assurance certification levels.
- A partner for your hoisting and handling needs in over 80 countries.



In France

9 sales agencies. 14 after-sales service station, 11 "EUROPONT overhead travelling crane production units and a network of dealers.

World-wide

Agencies in Germany, the Netherlands, Belgium and Italy, and dealers in Germany, Argentina, Austria, Spain and Brazil. Chile, Ireland, the United Kingdom, Sweden, Norway, Denmark, China, Thailand, Indonesia, Malaysia, Vietnam, India, the United States.



2, boulevard de l'Industrie - B.P. 59 - 28501 Vernouillet cedex - France
 Telephone: (33) 02 37 38 95 95 - Fax: (33) 02 37 38 95 99
 Internet : www.verlinde.com